

Vermont's GIS / H.657

Senate Committee on Finance

John E. Adams

Vermont Center for Geographic Information (VCGI)

April 2024



VERMONT

AGENCY OF DIGITAL SERVICES

Purpose

[10 V.S.A. Chapter 8: Geographic Information](#)

The Vermont Center for Geographic Information (VCGI) was created to develop and implement a “comprehensive strategy for the development and use of a geographic information system.”

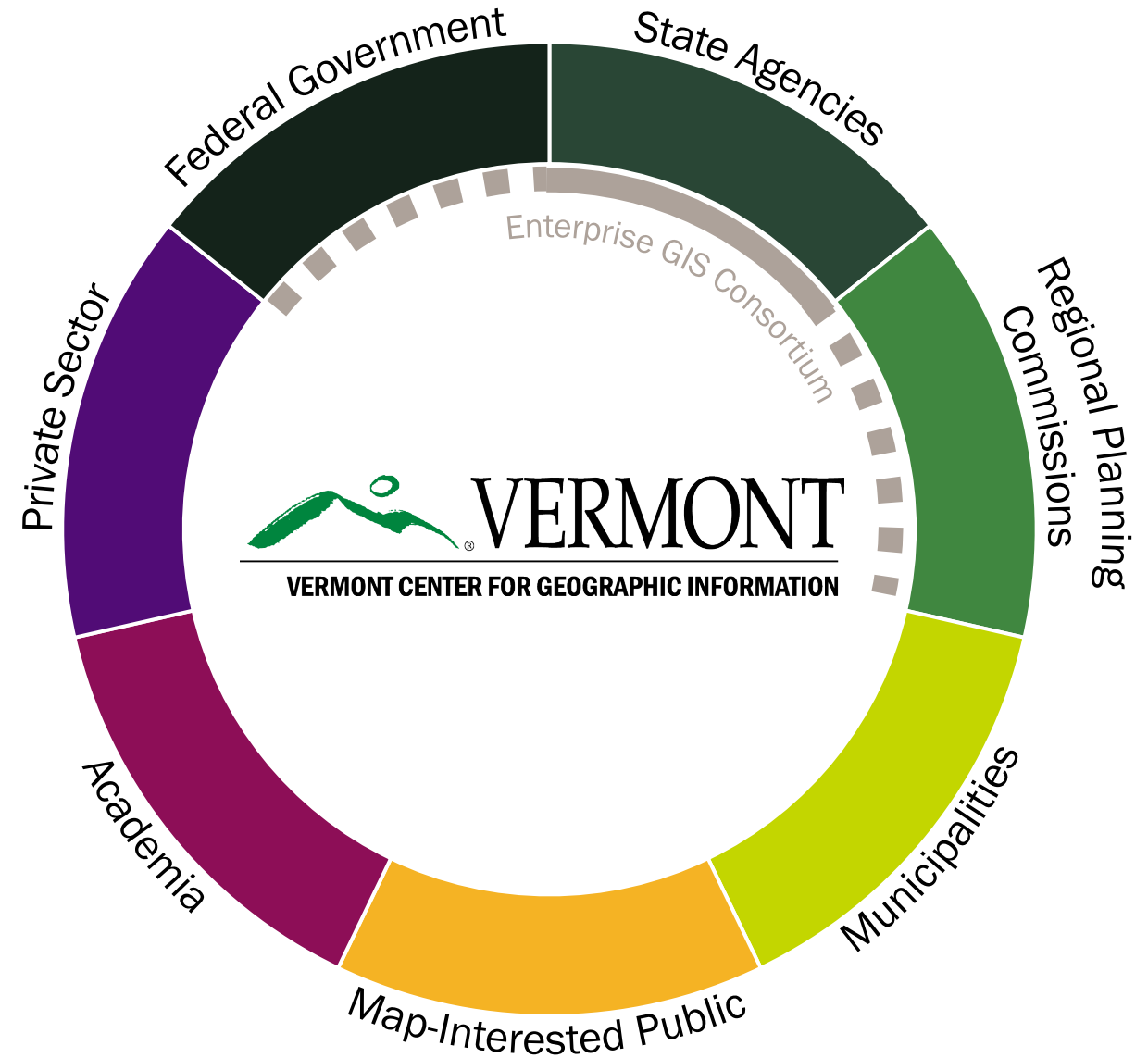

What VCGI Does



BUILD

Foundational
Datasets
(Spatial Data
Infrastructure)



LEAD

Development and
use of Statewide
Geographic Information
System (GIS) and the
Coordination it requires



EMPOWER

Data access,
visualization and use.



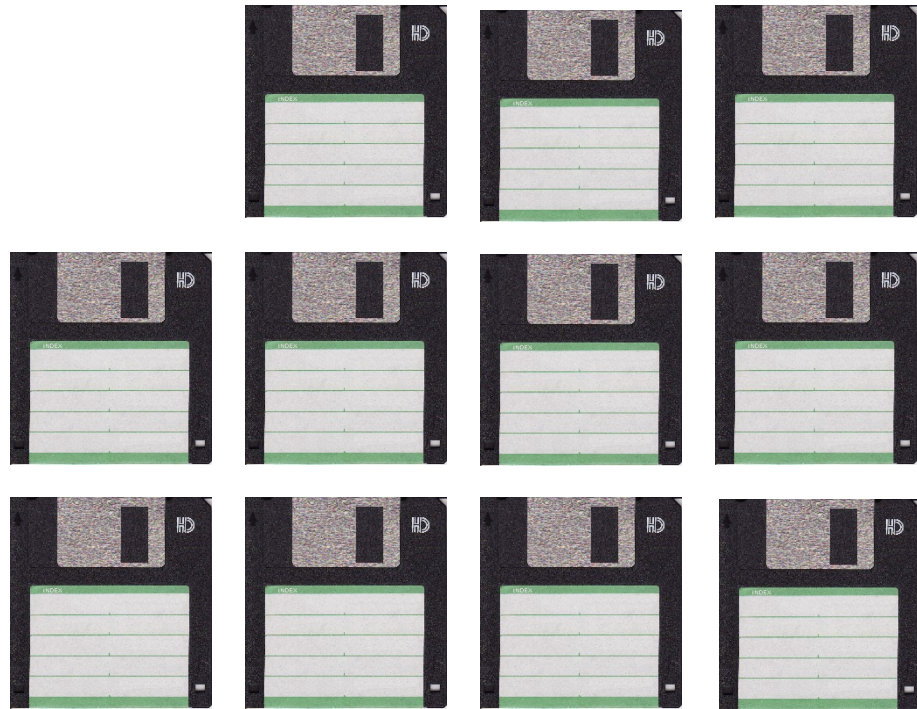

1992



MB



30 Years of Mapping

2022 marks the 30th anniversary of the passage of Act 258 which created the Vermont Center for Geographic Information, a part of the Data Division at the Agency of Digital Services. In 1992, staff (snail) mailed an average of three orders a week with floppy disks containing 17 MB of data. At the time, the Center estimated that demand for data over the next couple decades would grow a rate of 2%-10% annually, which (at the high end) would result in well under 2,000 users. These forecasts were off, as we now see over a half million visits a year from over 80,000 users accessing over 20TB of data. **In three decades, maps and spatial data have expanded from the niche world of tech-savvy geographers in academia and physical maps to a basic government service expected by the public, easily accessible online.** The growth and success of GIS in Vermont can largely be attributed to the collaboration of more than 20 different partner agencies, regional planning commissions, and others outside of government contributing to over 1000 datasets to the Open Geodata Portal. This group is now known as the Vermont Enterprise GIS Consortium.

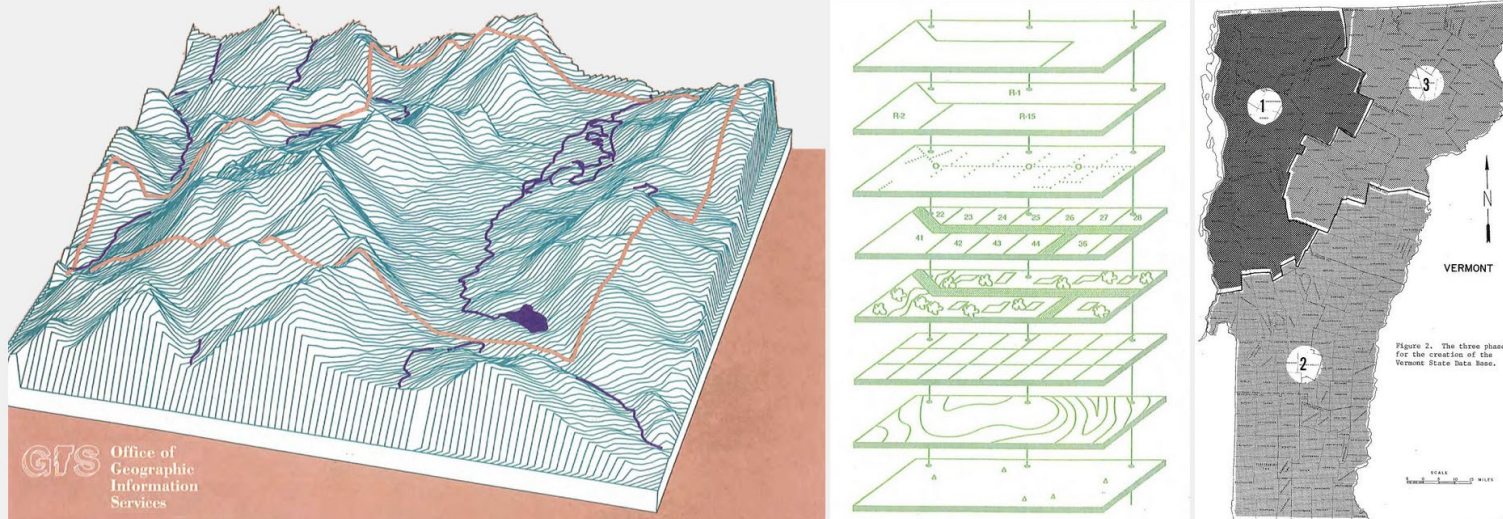

Early Vermont GIS Work: 1990's GIS for Vermont Communities: Applications and Concepts (left), 1989's VGIS Report to the Legislature (center), and 1983's The Creation of the Vermont State Database are all available at the [History of GIS in VT page at vcgi.vermont.gov](https://www.vt.gov/history-of-gis-in-vt).



FEDERATED DATA

DATA DOWNLOAD

SERVICES

APPS

LIKE
NETFLIX
FOR
MAPS



Spatial Data Infrastructure



Digital Orthoimagery

Elevation

Governmental Units

Cadastral (Parcels)

Land Cover

E911 Addresses (E911)

Transportation (VTrans)

Hydrography (ANR)

FGDC.GOV
FEDERAL GEOGRAPHIC DATA COMMITTEE



 **NSGIC**
National States Geographic Information Council

[See Geospatial Maturity Assessment Report Card](#)

 **VERMONT**
AGENCY OF DIGITAL SERVICES



Orthophotographic Imagery

SPECIFICATIONS

- Color and Infrared
- Leaf-Off, No Snow, No Clouds

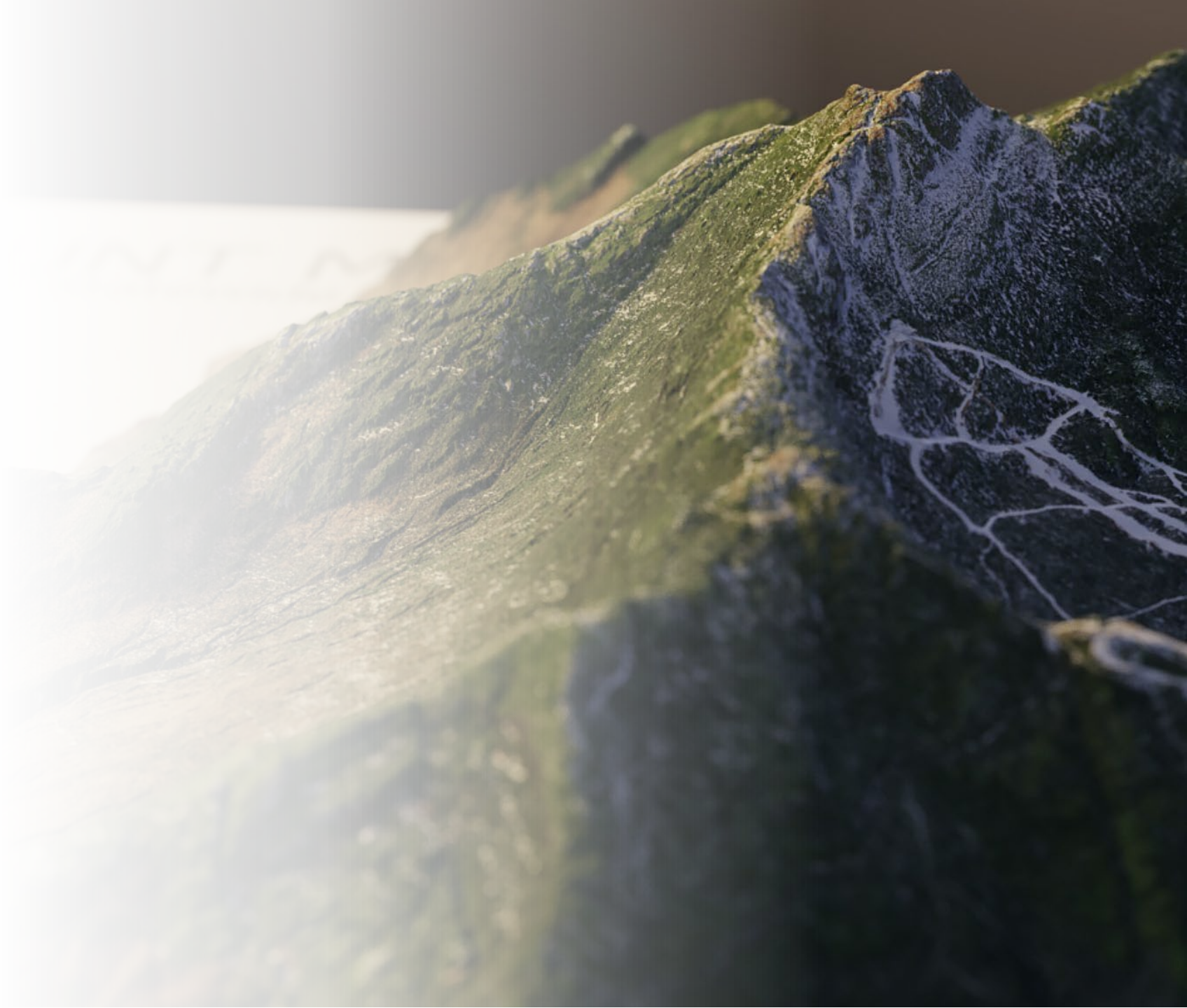
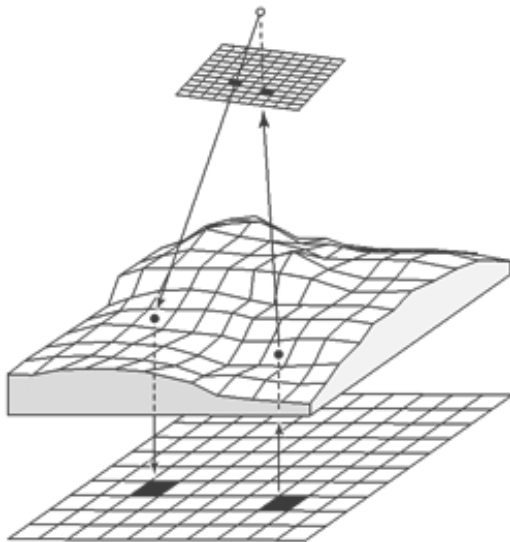



MAP GEOMETRY W/ SPAN
256 TOWNS



ANNUAL STATEWIDE
GRAND LIST from TAX

SPAN: 114-035-13809

MAPID	039-2-053-000
Property Type	PARCEL
GIS Year	2018
TOWN	BURLINGTON
Owship	CITY DPW, 645 PINE ST BURLINGTON, VT, 05401
Property Description	FORMER CITY DUMP MONITORING STATION CR
Category (Real Estate only)	Commercial
Resident Ownership Code	C
Zoom to	

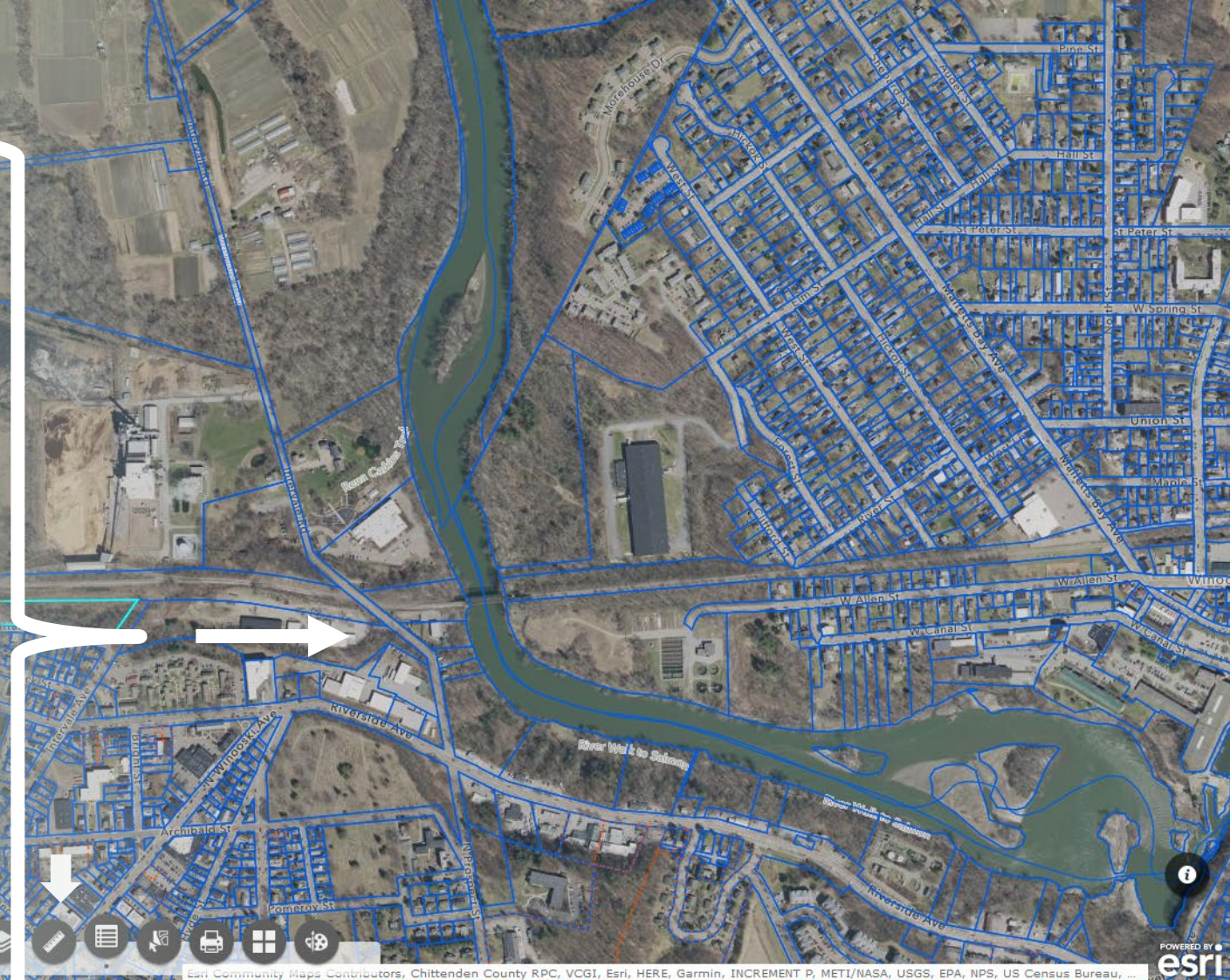

TOWN	Property Description	Category (Real Estate only)	Resident Ownership Code	Total Acres	Listed Real Value (Full)	Listed Value of Land	Listed Value of Improvements	Homestead Declared (Y/N)	Owship
BURLINGTON	FORMER CITY DUMP MONITORING STATION CR	Commercial	C	37.70	521,200	508,600	12,600	N	CITY DPW, 645 PINE ST BURLINGTON, VT, 05401



What is lidar?

Light Detection and Ranging (lidar) is a technology used to create high-resolution models of ground and surface elevation. Lidar data are collected from aircraft using sensors that detect the reflections of a pulsed laser beam. The reflections are recorded as billions of individual points, which are processed into digital three-dimensional models of Vermont in formats readily accessible for use by state agencies, partners, and the public.

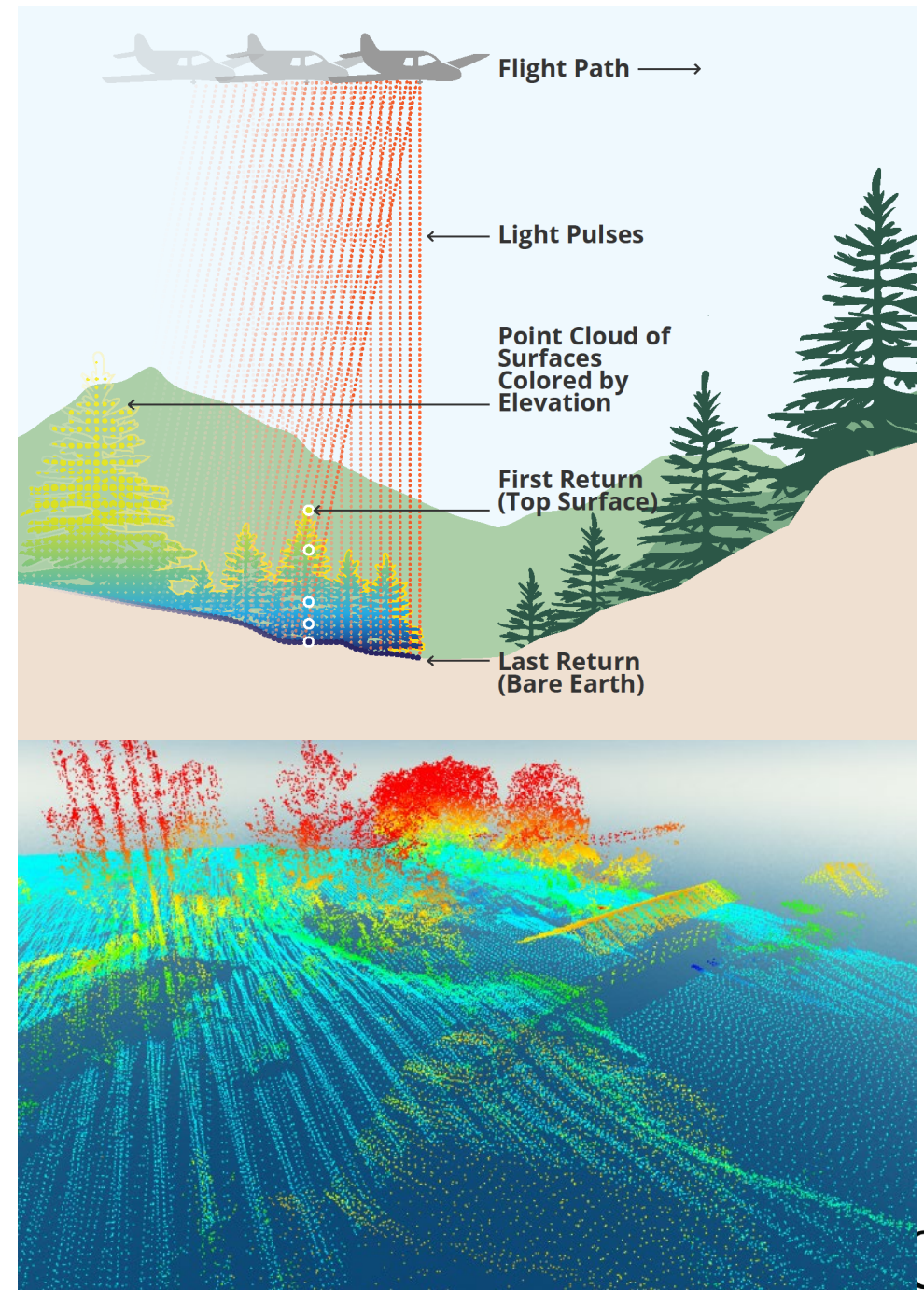

Point Clouds

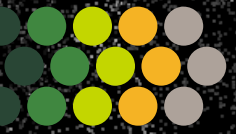

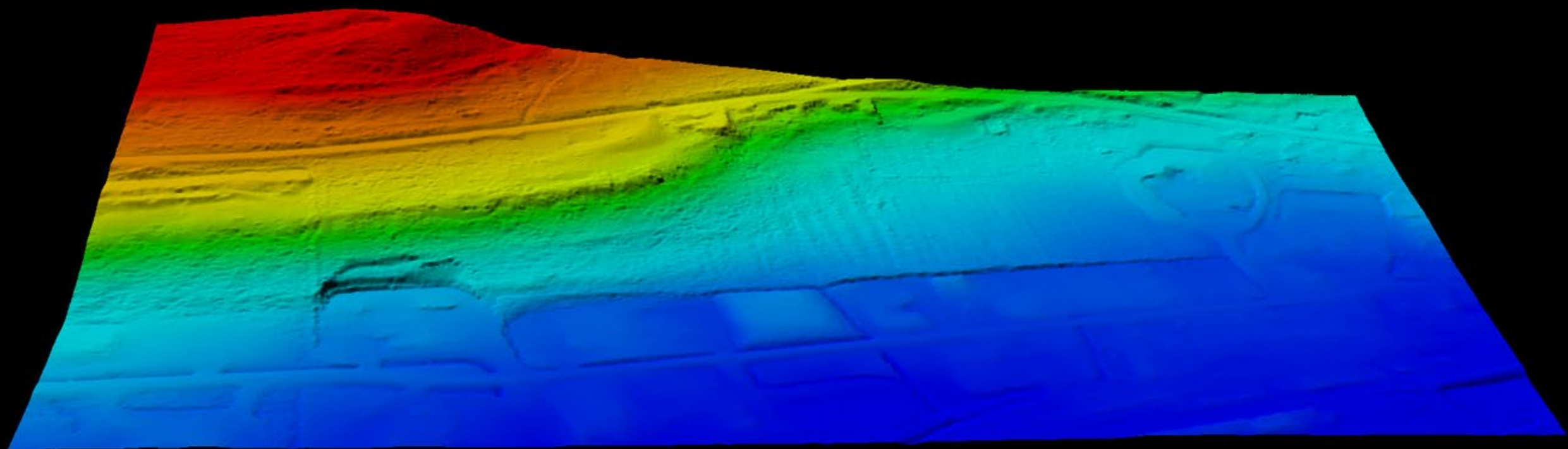
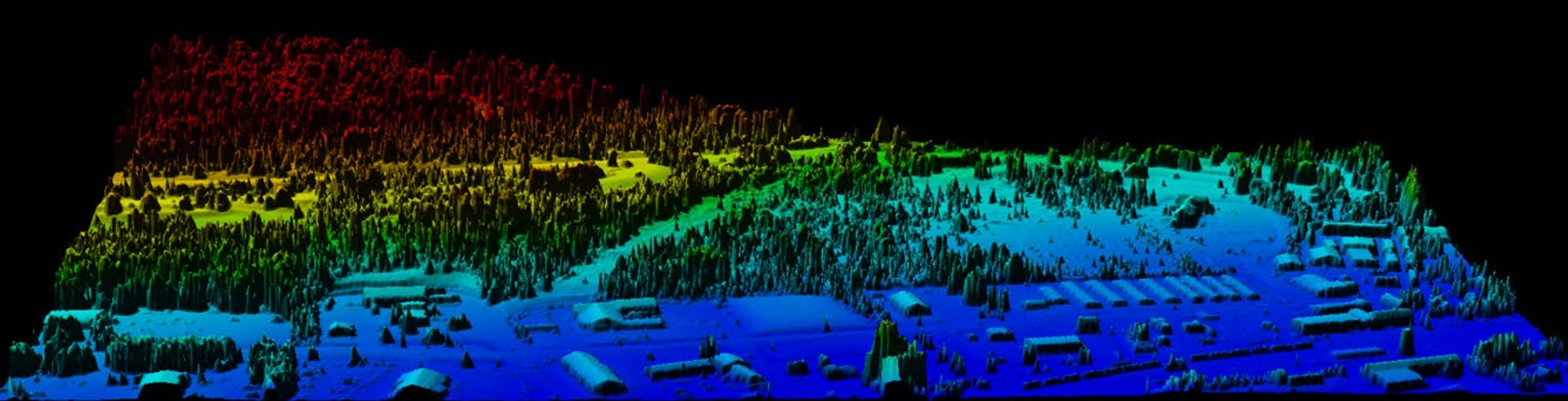

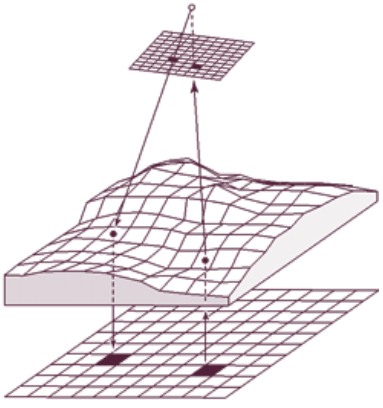

ORTHOIMAGERY

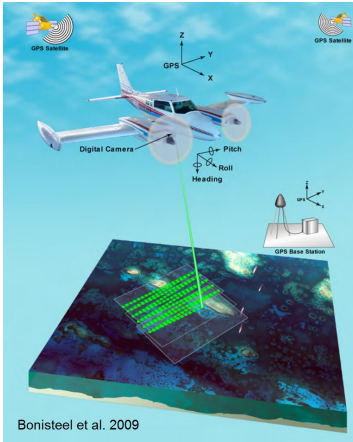

Bonisteel et al. 2009

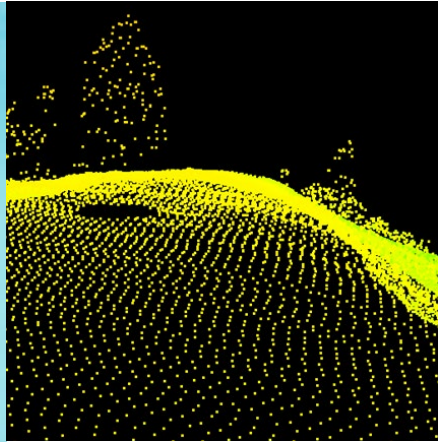

LIDAR

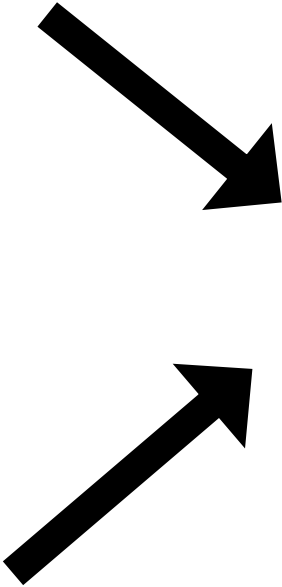

Land Cover

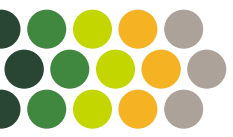

Thank you Jarlath.

Thanks to the work of the [UVM Spatial Analysis Lab](#), Vermont has the highest resolution land cover data in the country.



Use this map to view before and after imagery of areas heavily impacted by the July 2023 flood. Layers may be turned on or off to view more map features.

How to use this tool: Enable the "Swipe" tool below by toggling the radio button to view before and after imagery side-by-side. You may also recenter the map by clicking a preloaded location below.

- Swipe
- Leading layers
- Trailing layers

Choose a location:

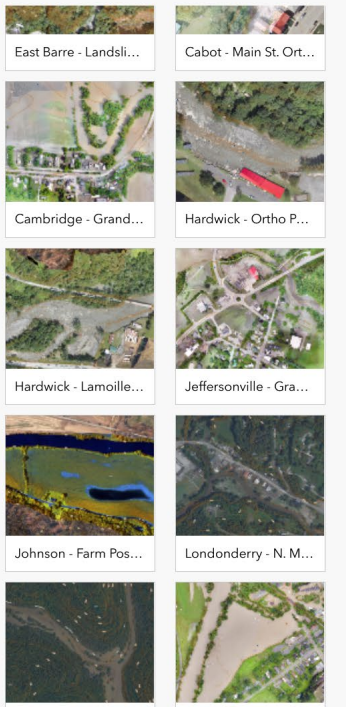

Layers

- Oblique Photos
- Video
- Civil Air Patrol Imagery
- Aerial Oblique Photo Points
- Aerial Nadir
- Ground Photo Points
- Buildings - Residential/Non-Residential
 - SINGLE FAMILY DWELLING
 - MOBILE HOME
 - MULTI-FAMILY DWELLING
 - CONDOMINIUM
 - OTHER RESIDENTIAL
 - SEASONAL HOME
 - Other
- Parcels
 - Active Parcels
- Flood Depth (ICEYE)
 - 12' - 16.417'
 - 9' - 12'
 - 6' - 9'
 - 3' - 6'
 - 1' - 3'
 - ~1' - 1'



Chose a preloaded scene
Note: Some scenes are intensive to render

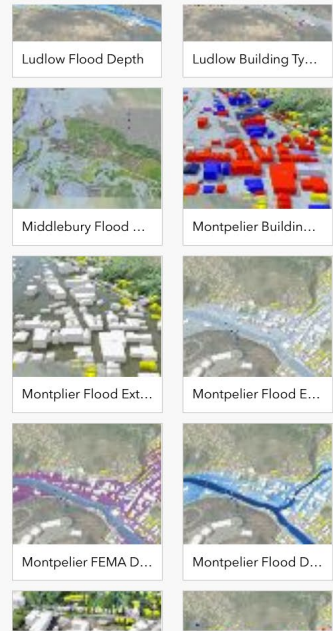

Or create your own with the available layers:

- Reference Labels and Roads
- ARPA Funded Projects
- 3D Buildings (ESRI)
- Flood Extent (ICEYE)
- Flood Depth (ICEYE)
- Photos and Video (UVM, AOT)
- Civil Air Patrol Photos
- Parcels
- Contours
- Reference Inundation Layers
- Steep Slopes 51% and Above

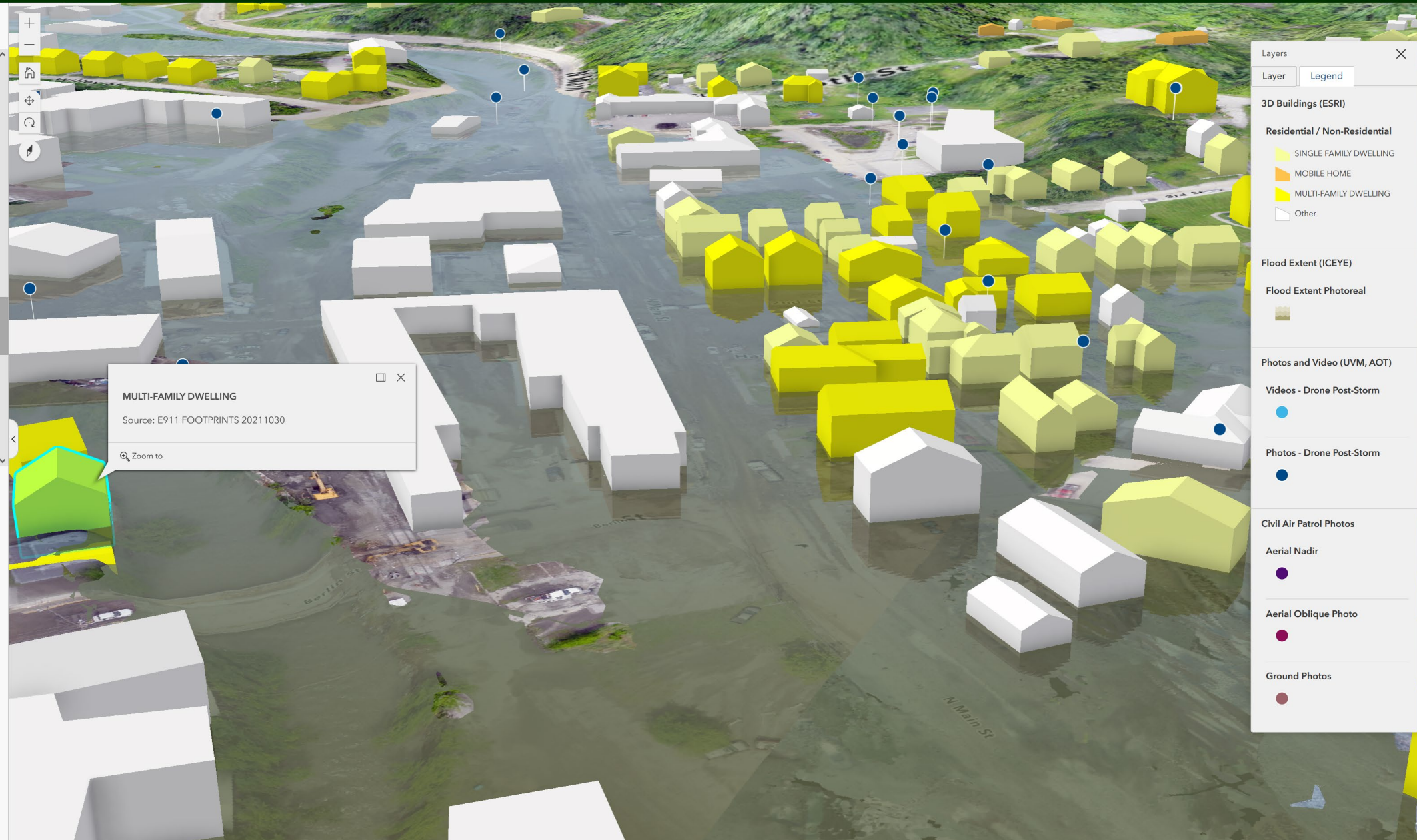

MULTI-FAMILY DWELLING

Source: E911 FOOTPRINTS 20211030

Zoom to

Layers Legend

3D Buildings (ESRI)

Residential / Non-Residential

- SINGLE FAMILY DWELLING
- MOBILE HOME
- MULTI-FAMILY DWELLING
- Other

Flood Extent (ICEYE)

Flood Extent Photoreal

Photos and Video (UVM, AOT)

Videos - Drone Post-Storm

Photos - Drone Post-Storm

Civil Air Patrol Photos

Aerial Nadir

Aerial Oblique Photo

Ground Photos



Parcels & Right-of-Way Mapping



Telecommunications & Connectivity

Search, View and Use Telephone, Mobile Wireless, and Broadband Data

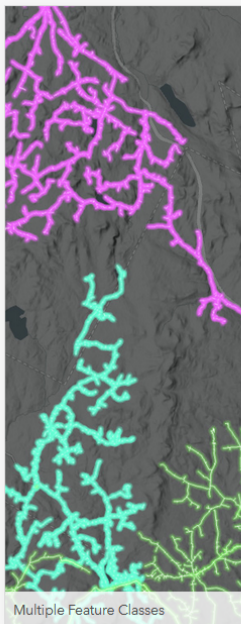

Utility Poles and Lines

These datasets contain point and line features representing utility poles and lines as provided by their management entities.

Data reflect information made available to the Public Service Department and are maintained by each respective management entity--see individual items for details.

Green Mountain Power (GMP) Poles

[Service Endpoint](#) [Download Page](#)

Green Mountain Power (GMP) Lines (Includes Overhead and Underground)

[Service Endpoint](#) [Download Page](#)

Vermont Electric Cooperative (VEC) Poles

[Service Endpoint](#) [Download Page](#)

Vermont Electric Cooperative (VEC) Lines

[Service Endpoint](#) [Download Page](#)

Washington Electric Cooperative (WEC) Poles

[Service Endpoint](#) [Download Page](#)

Washington Electric Cooperative (WEC) Lines

[Service Endpoint](#) [Download Page](#)

Multiple Feature Classes

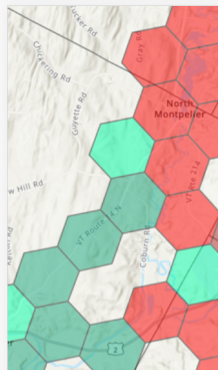

Mobile Wireless Signal Drive Tests

These datasets contain mobile wireless download speed test results and areas where the PSD (Vermont Public Service Department) challenged mobile wireless service asserted by wireless carriers.

2022 Drive Test - Voice Test Totals

[Service Endpoint](#) [Overview Page](#)

2022 Drive Test - Speed Test Totals

[Service Endpoint](#) [Overview Page](#)

2022 Drive Test - Voice Test Results

[Service Endpoint](#) [Overview Page](#)

2022 Drive Test - Speed Test Results

[Service Endpoint](#) [Overview Page](#)



Feature Class (point)

Broadband Status

Broadband service at buildings in Vermont by speed, as reported by broadband service providers and aggregated by PSD.

[Service Endpoint](#) [Download](#)



Feature Class (line)

Cable Routes

Roads where cable television service is available.

[Service Endpoint](#) [Download](#)

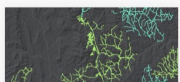

Feature Class (line)

Fiber Routes

Roads served by fiber to the home (FTTH) broadband service providers throughout Vermont.

[Service Endpoint](#) [Download](#)

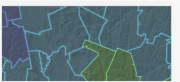

Feature Class (polygon)

Telephone Service Areas

Wirecenter service territories of the incumbent local exchange carriers (ILECs).

[Service Endpoint](#) [Download](#)



Feature Class (point)

Microcell Sites

Locations where state-owned roadside microcell transmitters are installed. (forthcoming)

[Service Endpoint](#) [Download](#)



Feature Class (point)

248a Tower Permit Sites

Locations where permits were issued for towers under 30 VSA 248a by the Vermont Public Utility Commission.

[Service Endpoint](#) [Download](#)



Feature Class (polygon)

Electric Utility Service Areas

Electric utility service areas throughout Vermont.

[Service Endpoint](#) [Download](#)

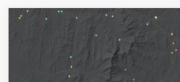

Feature Class (point)

Electric Substations

Locations of electric substations throughout Vermont.

[Service Endpoint](#) [Download](#)

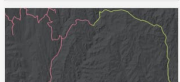

Feature Class (line)

Open Access Fiber Routes

Routes where open access state-owned fiber is installed throughout Vermont.

[Service Endpoint](#) [Download](#)

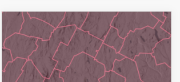

Feature Class (polygon)

Telephone Exchange Boundaries

Represents Vermont Telephone Exchange boundaries as defined by the VT Public Service Board.

[Service Endpoint](#) [Download](#)



Feature Class (polygon)

Communications Union Districts

Boundaries of Communications Union Districts (CED), which allow two or more towns to bond together as a municipal entity for a means of building communication infrastructure together.

[Service Endpoint](#) [Download](#)



Vermont Utility Pole GIS Data Standard

[VT GIS Standard](#)

Wednesday, December 9, 2020 - 12:00

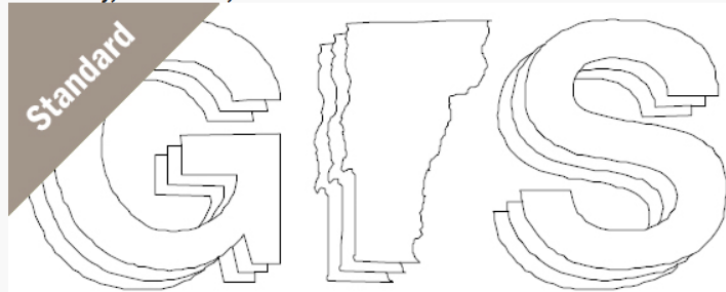

The purpose of the VT GIS Pole Data Standard is to foster a uniform system for pole information. It is designed for all utilities and telecom organizations to effectively plan and manage their infrastructure over time. The Standard identifies the type and form of information about utility poles that are most useful. This can be used to guide decisions about what information to collect and maintain on these assets.

Applicability

This Standard is for use by all of Vermont's pole-owning utilities and telecom organizations and their consultants or contractors.

Maintenance

The Vermont Department of Public Service is the steward for the Standard. Individual pole owners are responsible for the datasets related to poles they own.

Adoption

Nothing in this Standard requires its adoption, either in whole or in part, by any entity, including pole owners or other users.

File

[VT Pole Data GIS Standard](#) (238.18 KB)

<https://vcgi.vermont.gov/document/vermont-utility-pole-gis-data-standard>

Fields

Field	Data Type	Description
Latitude	Double	Coordinate
Longitude	Double	Coordinate
OBJECTID	Object ID	Sequential
CREATIONUR	String	The user or designer who created the facility
DATECREATE	Date	The date that the facility was created
DATEMOD	Date	The date that the facility was last modified
LASTUSER	String	The last user or designer to modify the facility
POLETAG	Text	Unique code assigned by pole owner
LOCATIONID	Text	Unique code assigned by pole owner
OWNER	Text	Pole owner Acronym
POLEHEIGHT	Long Integer	Height above ground level in decimal feet
CLASS	Text	Pole class
POEMAT	Text	Pole Material
INSTALLDAT	Date	Installation date mm/dd/yyyy
COLLECTDEV	Short Integer	1,2,3
DEVPREC	Short Integer	1,2,3
POLEUSE	Text	Pole Use
MAINTENANC	Text	Utility responsible for service
TELROUTE	Text	Unique code assigned by pole owner
TELPOLE	Text	Unique code assigned by pole owner
JCTPOLE	Text	Y/N (Is Pole a Junction) (Default N)
SHAPE	Geometry	Table Mandatory
TRANSFRMR	text	Y/N
TRANSEXESS	Text	Y/N (Is there extra loop cable hanging)
GUYS	text	Pole to pole, Down, or N
ANCHORNEED	text	Y/N
HDWRATTACH	text	Y/N (cable amplifier, DSLAM, etc.)
RISERS	text	Y/N
CUSTDROPS	short integer	Quantity
TPTATTACH	text	Y/N (Third-party, other than ILEC)



Learn More: 2023 Year in Review

